

# Ranger

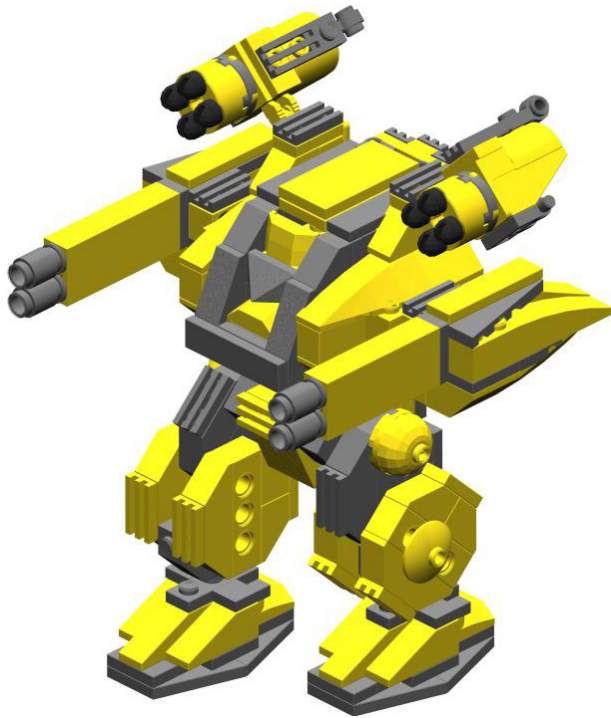

				x6	x2	x10	x13
				x2	x2	x2	x3
				x2	x1	x8	x3
				x6	x2	x4	x1
				x2	x1	x2	x3
				x6	x2	x2	x2
				x2	x2	x1	x2
				x1	x2	x2	x4
				x2	x2	x2	x7
				x4	x4	x2	x4
				x4	x2	x8	x1
				x4	x2	x2	x8
				x2	x8	x2	x2
				x4	x2	x8	x2
				x2	x2	x5	x12
				x4	x1	x6	x1
				x2	x1	x2	x4
				x2	x2	x2	x4
				x2	x2	x2	x5

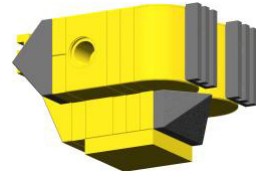
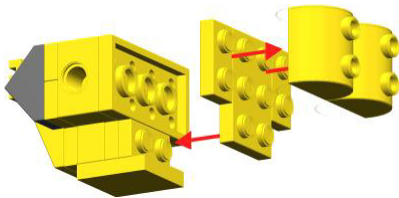
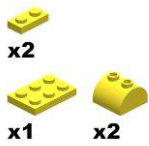
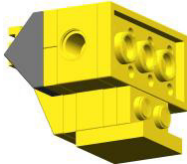
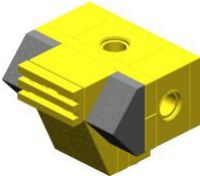
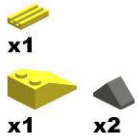
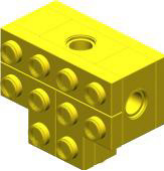
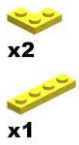
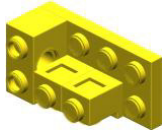
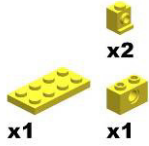

2x

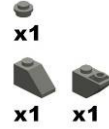

2x

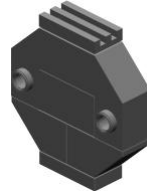
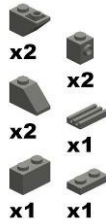

4x

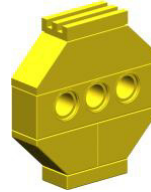
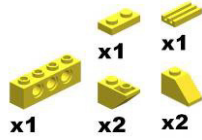

2x

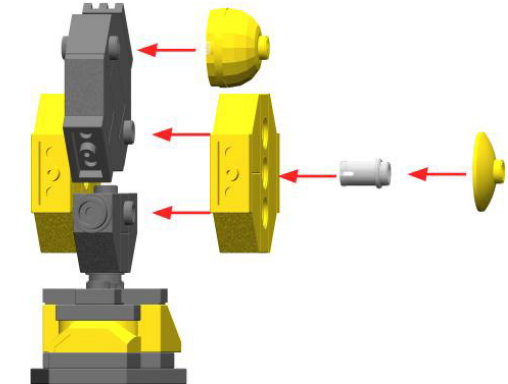
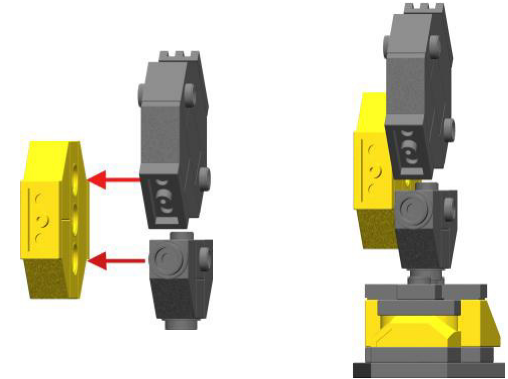
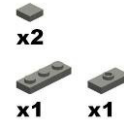
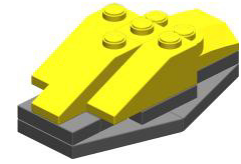
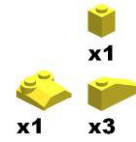
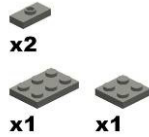

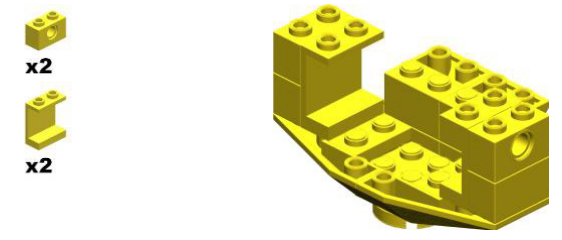
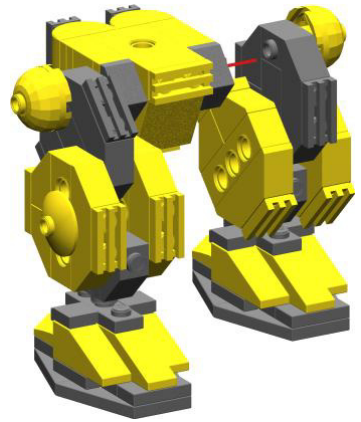
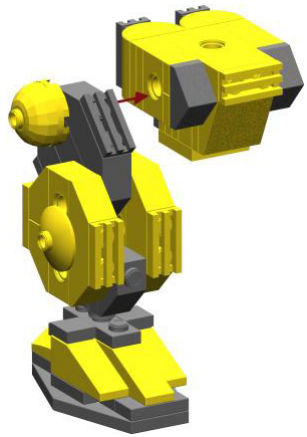

- x2
- x2

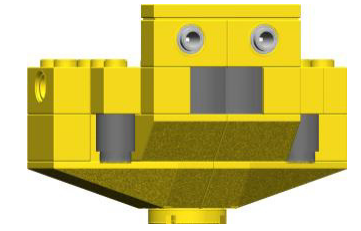

- x2
- x2
- x2
- x1
- x2
- x2
- x1

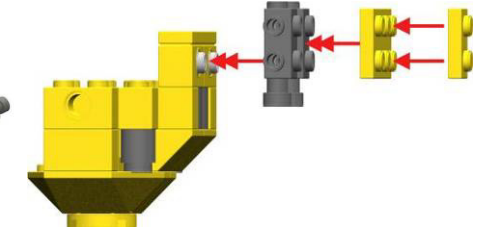

- x1
- x1
- x2

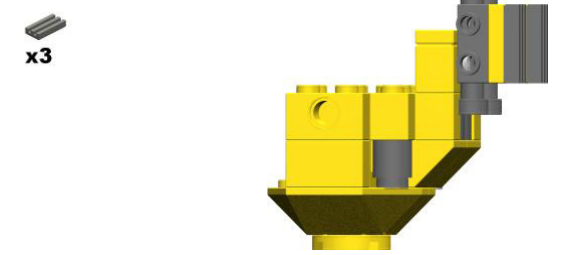

- x3

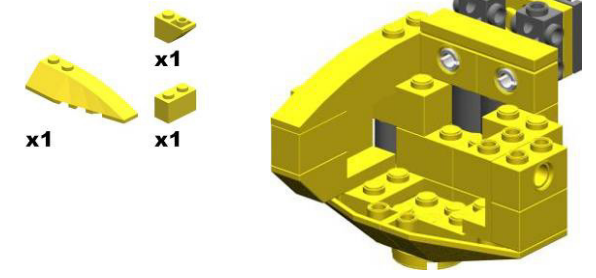

- x1
- x1

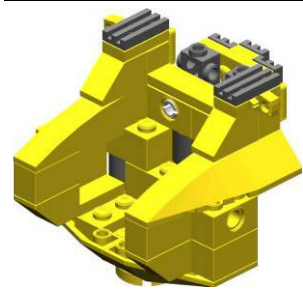
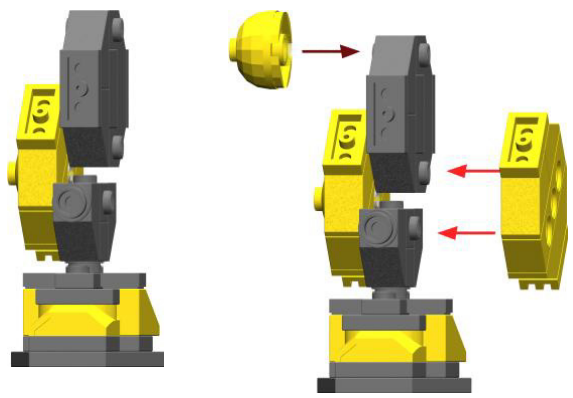
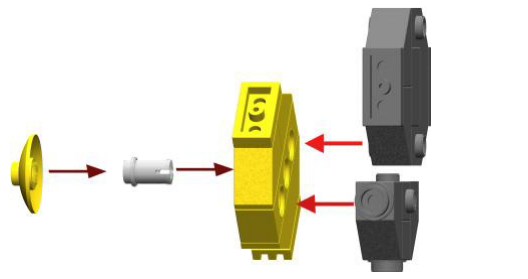

- x1
- x2
- x2
- x1

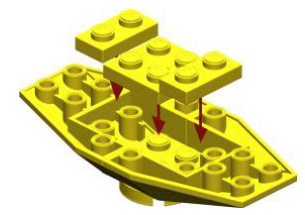
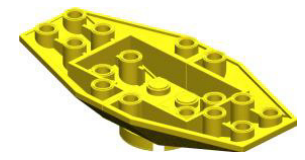

- x2
- x2

