



6936



4299706

1

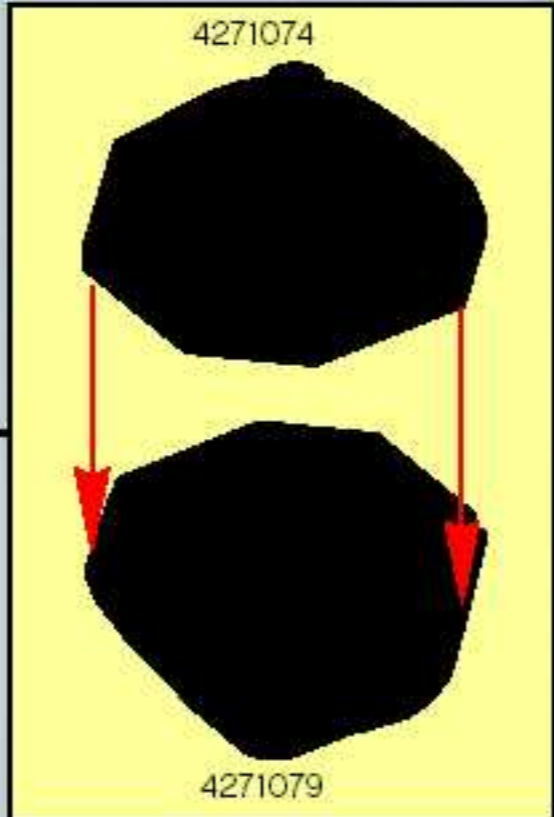
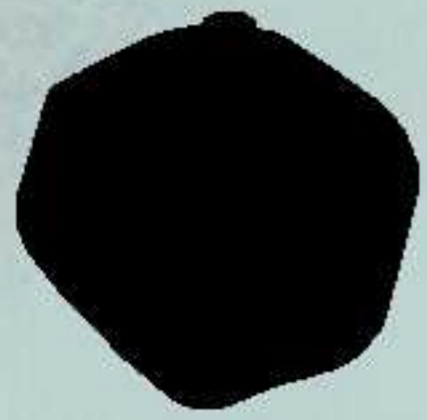

1

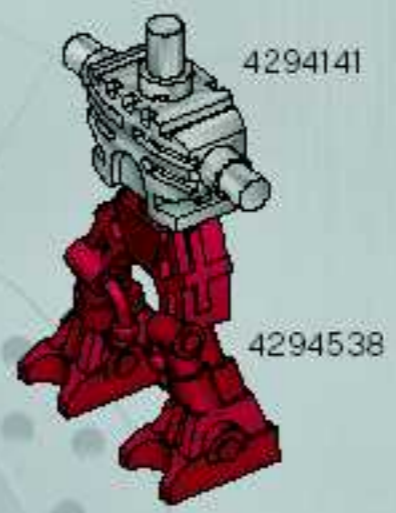

2



3

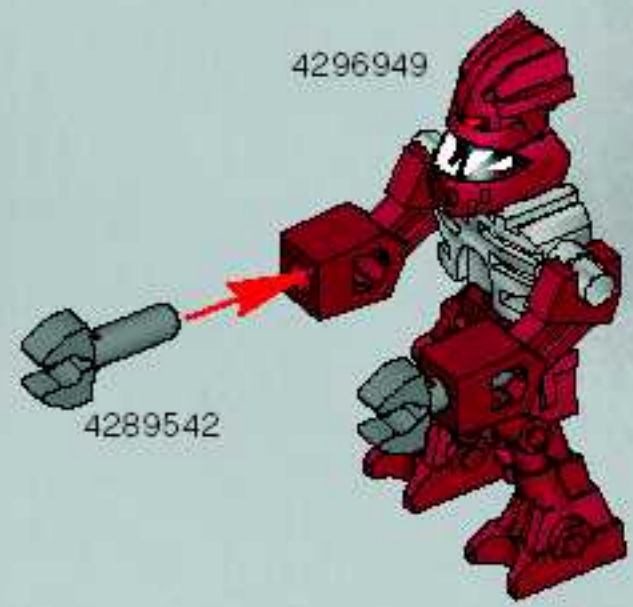

4

