

MINI AT-OT

Original Design by FBTB User **bigospedros**
 Instructions by FBTB User **kyphur**

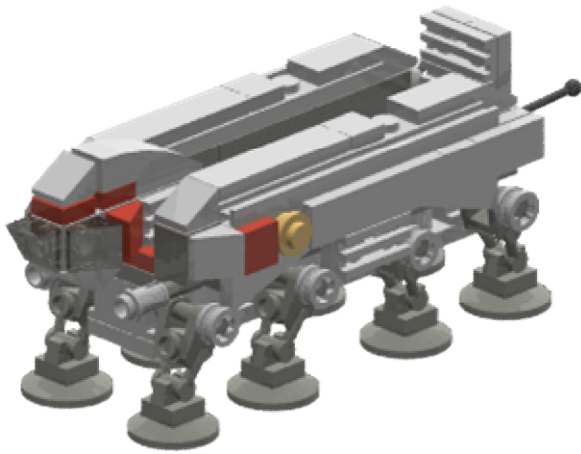

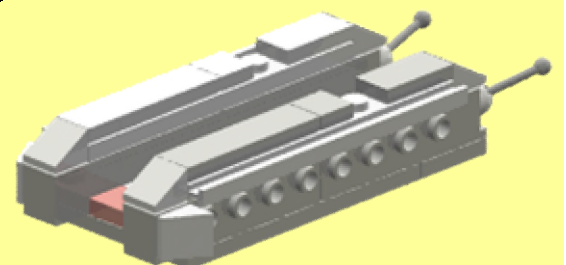

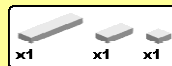
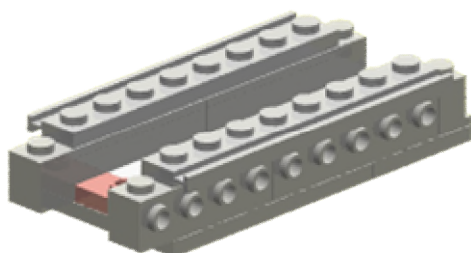
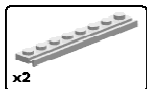
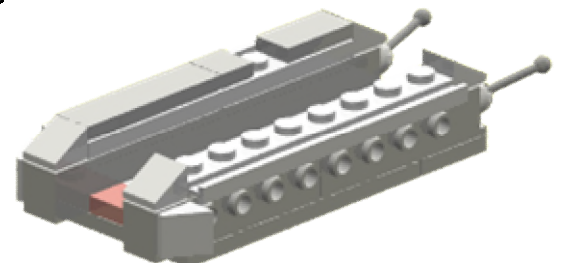
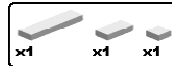
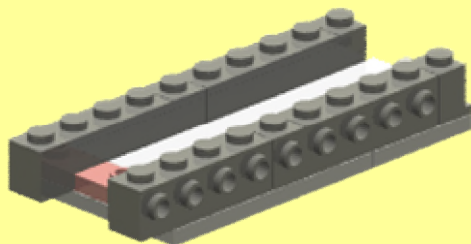
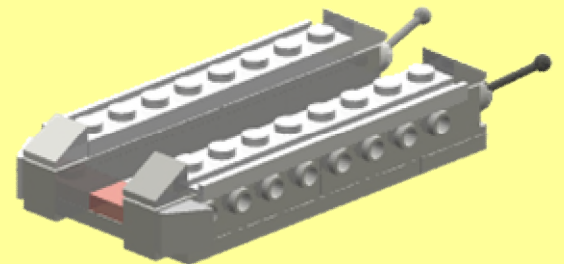
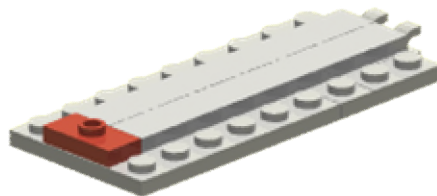
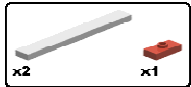
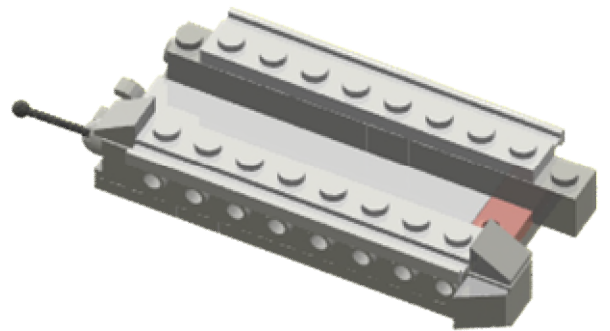
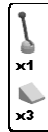
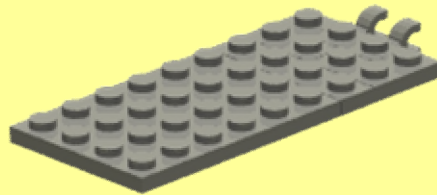
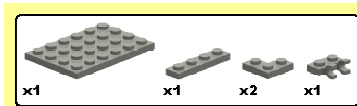

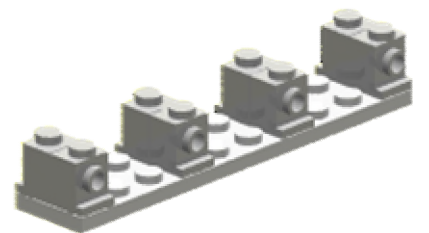
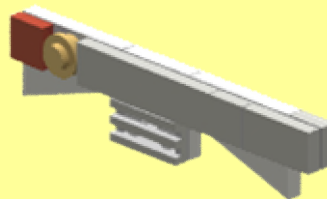
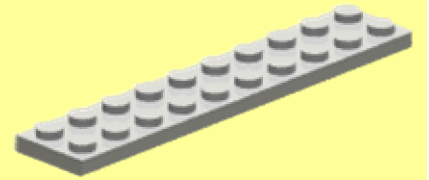
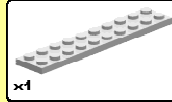
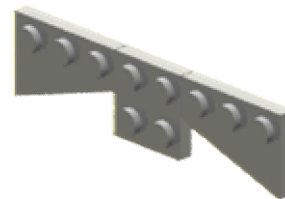
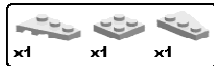
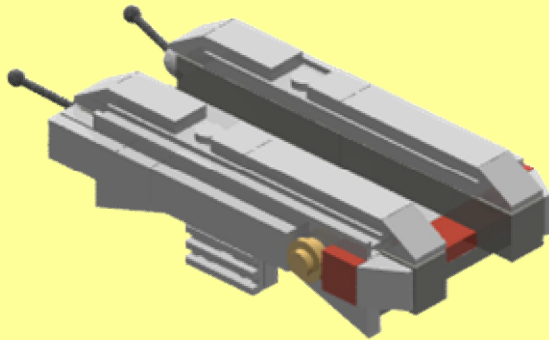
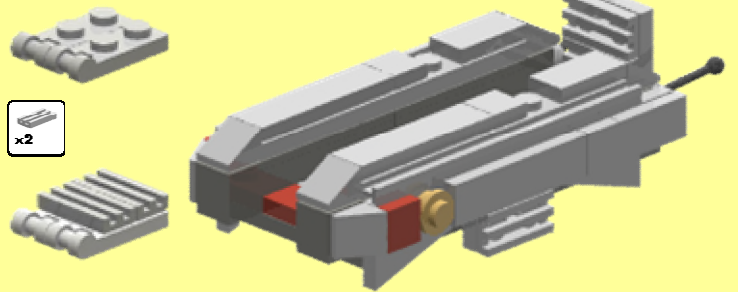
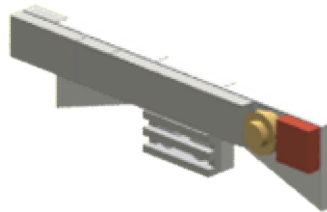
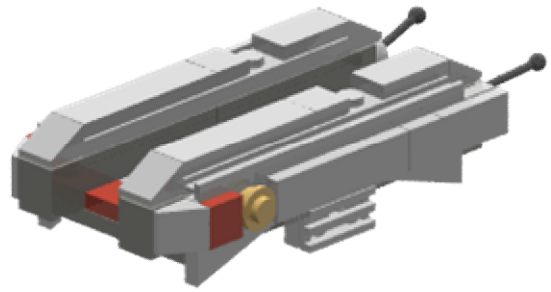
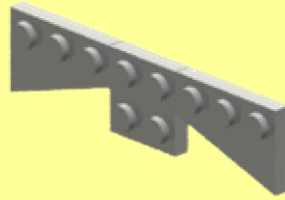

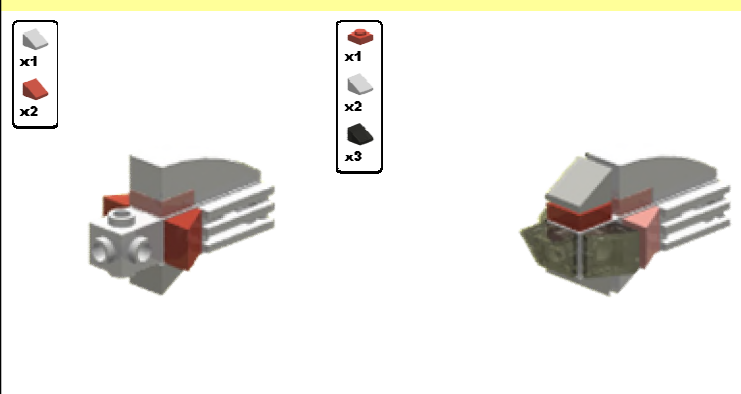
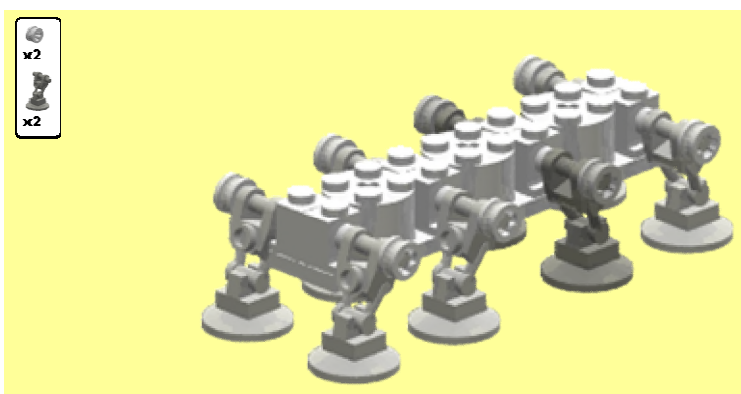
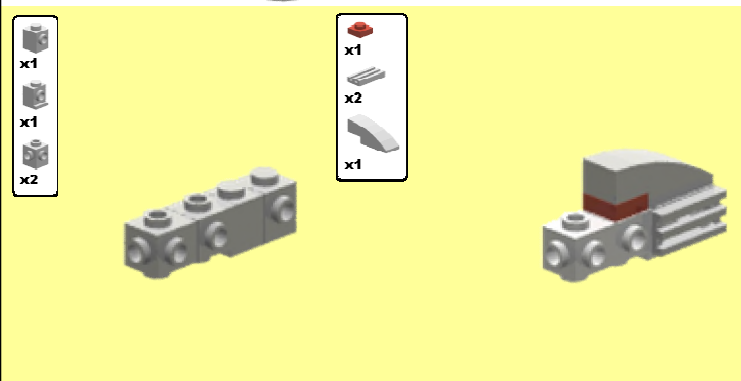
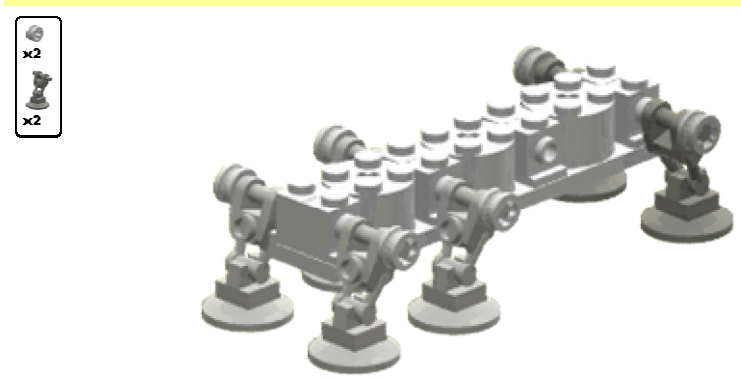
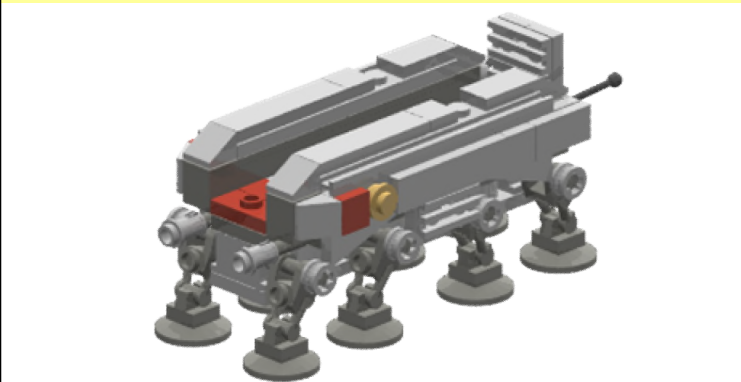
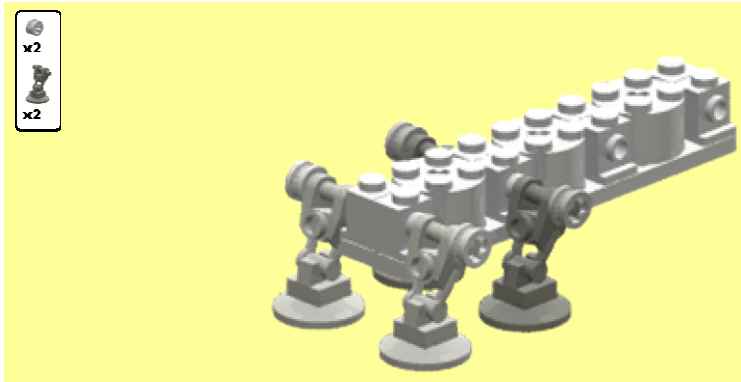
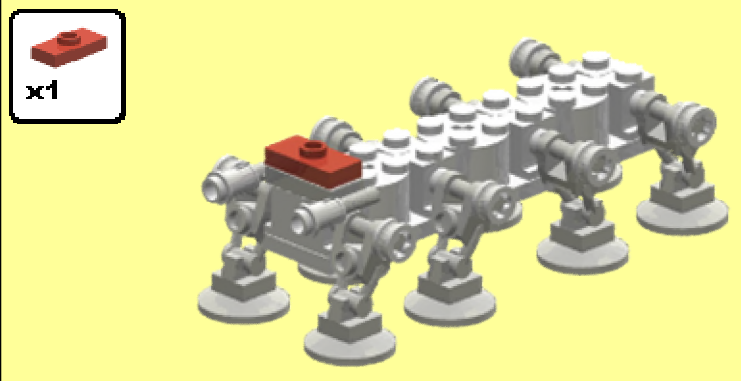
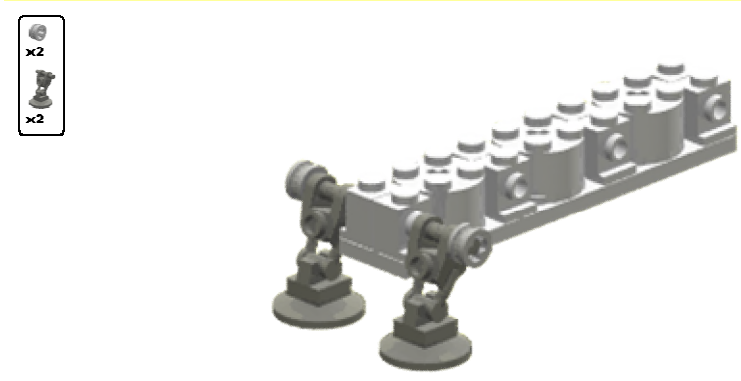
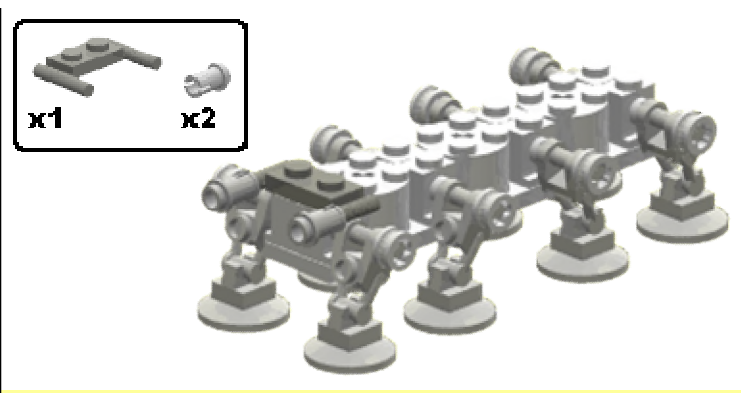
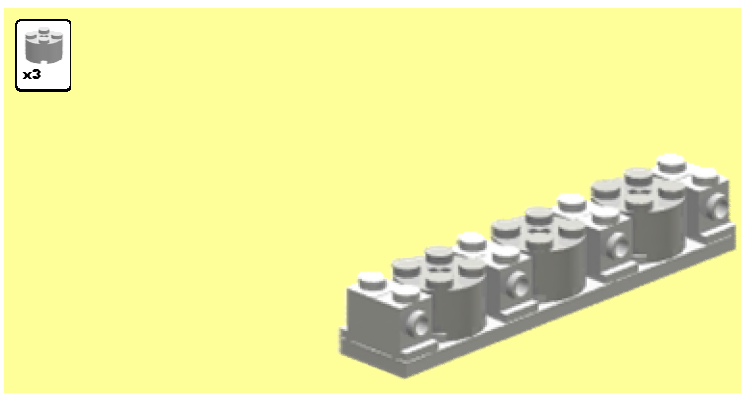

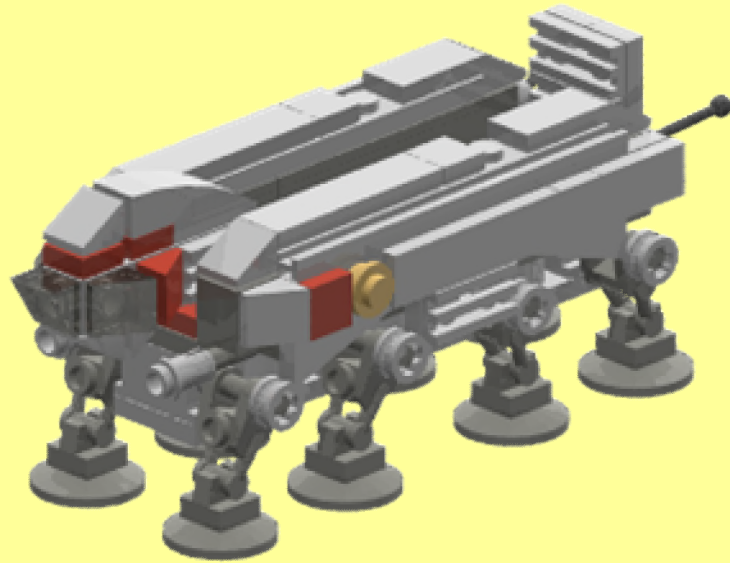

































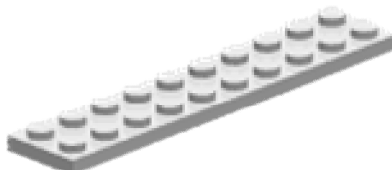



This MINI AT-OT is designed so that the MINI Republic Dropship presented by The LEGO Group at 2009 San Diego Comic-Con can lift and carry it.









- | | | | | | |
|---|---|---|--|---|---|
|  |  |  |  |  |  |
| x1 | x2 | x4 | x2 | x2 | x8 |
|  |  |  |  |  |  |
| x9 | x2 | x2 | x2 | x4 | x4 |
|  |  |  |  |  |  |
| x3 | x1 | x2 | x2 | x8 | x8 |
|  |  |  |  |  |  |
| x2 | x2 | x2 | x1 | x6 | x6 |
|  |  |  |  |  |  |
| x1 | x2 | x2 | x2 | x4 | x4 |
|  |  |  |  |  |  |
| x8 | x1 | x2 | x9 | x4 | x4 |
|  |  |  |  |  |  |
| x2 | x1 | x1 | x2 | x2 | x2 |
|  | |  |  |  | |
| x8 | | x2 | x3 | x2 | |